





Your chimney for life

cheminées Poujoulat

Standard finishes



RAL 9019
Matt Black



RAL 8004
Copper Brown

Other Ral Colour on demand

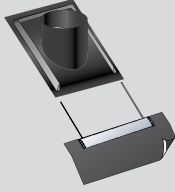

STI flashings
Black or Copper Brown
Including malleable
weathering skirt & foam

Key Benefits Using STI Stack

- Aesthetically pleasing
- High quality
- Quick and easy to install
- 10 year AXA guarantee

Fully welded
all-weather collar

**FAST, CLEAN, EASY
INSTALLATION
BECOMES
STANDARD**

PRACTICAL
Our STI Chimney Stack is designed to enable the chimney to be installed on the roof first.



Therminox TI & ZI
316L stainless steel
inner liner

STI CHIMNEY STACK

Self supported chimney stack

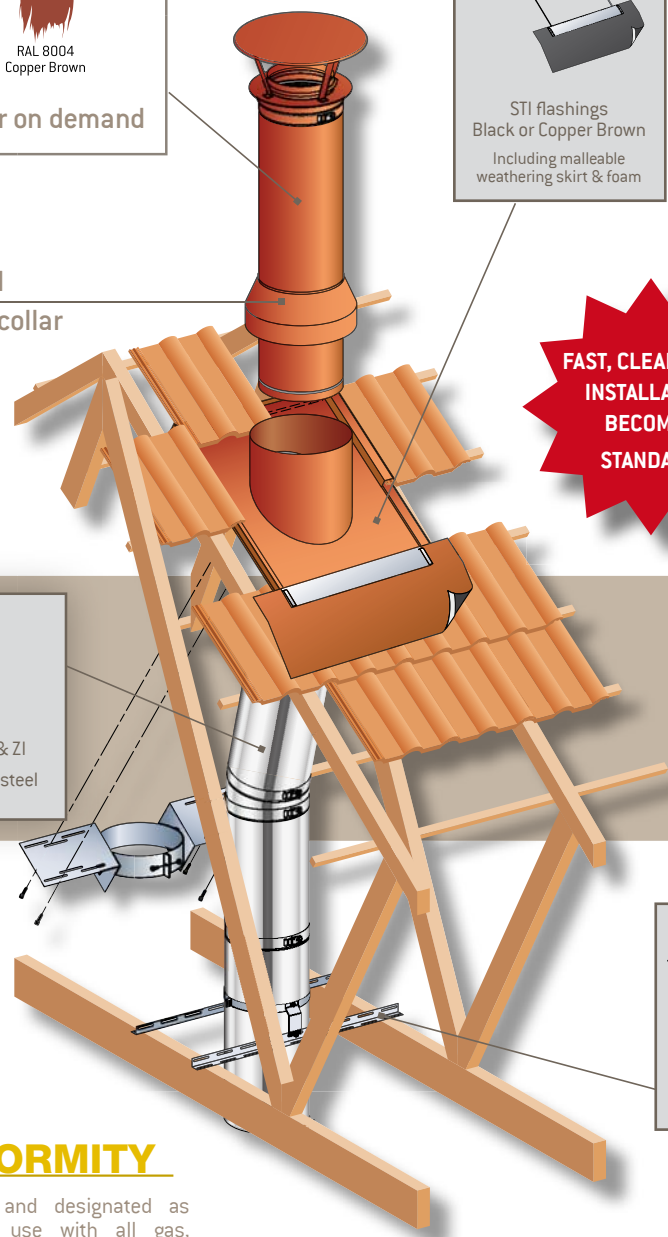
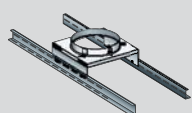
Joist Support
Galvanised steel

CONFORMITY

CE marked and designated as suitable for use with all gas, oil, pellet and wood burning appliances.



STI CHIMNEY STACK -Innovative evolution of the standard Therminox and Dualis PGI chimney termination using modern engineering design principle, combined with state of the art manufacturing process. This provides a simple solution for mounting chimney on the roof.

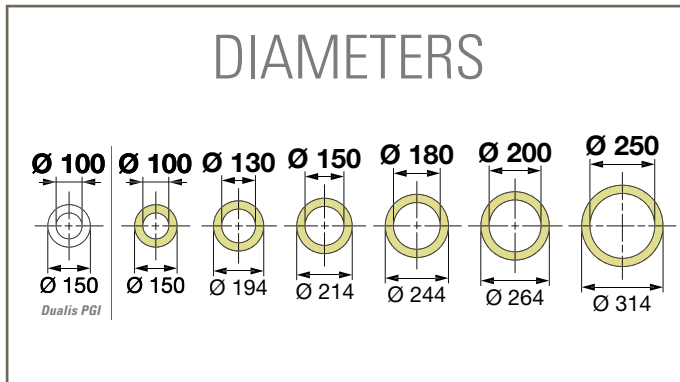

FINISHES AVAILABLE

Standard Colours



Matt Black
RAL 9019



Copper Brown
RAL 8004



Stainless
Steel

RAL Colours



Painting is an additional + 20%
to the Therminox STI Stack Price

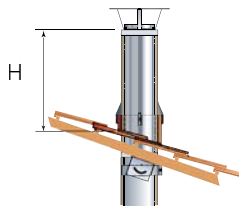

Models	H
STI 800 S TZ	800
STI 900 S TZ	900
STI 960 S TZ	960
STI 1160 S TZ	1160*

*Not available in Ø100 system

PRINCIPLE FEATURES

- > **Inner wall material:** 316 stainless steel 0.4 mm thick
- > **Outer casing:** Stainless steel 0.4 mm thick
- > **Max. Temperature limitation:**
 - > Soot fire tested at 1000°C
 - > Operating temperature 450°C
- > **Insulation:** High pressure injected mineral wool 30mm thick.
- > **Aesthetics:** Fully welded all-weather collar.
- > **4 hours fire rated** to BS 476-20

BENEFITS

- > Up to 3m freestanding above roof.
- > Aesthetically pleasing look.
- > Guaranteed leak-free flue collar.
- > Quick and easy to install.
- > Customer satisfaction.
- > Easily meets regulation requirements.

Product certified: **BS EN 1856-1:2003**

CE 0071 CPD 011

T450 N1 W V2L50 040 G50

T250 N1 W V2L50 040 O20

T200 P1 W V2L50 040 O20

(with seal)

